

4

3

2

1

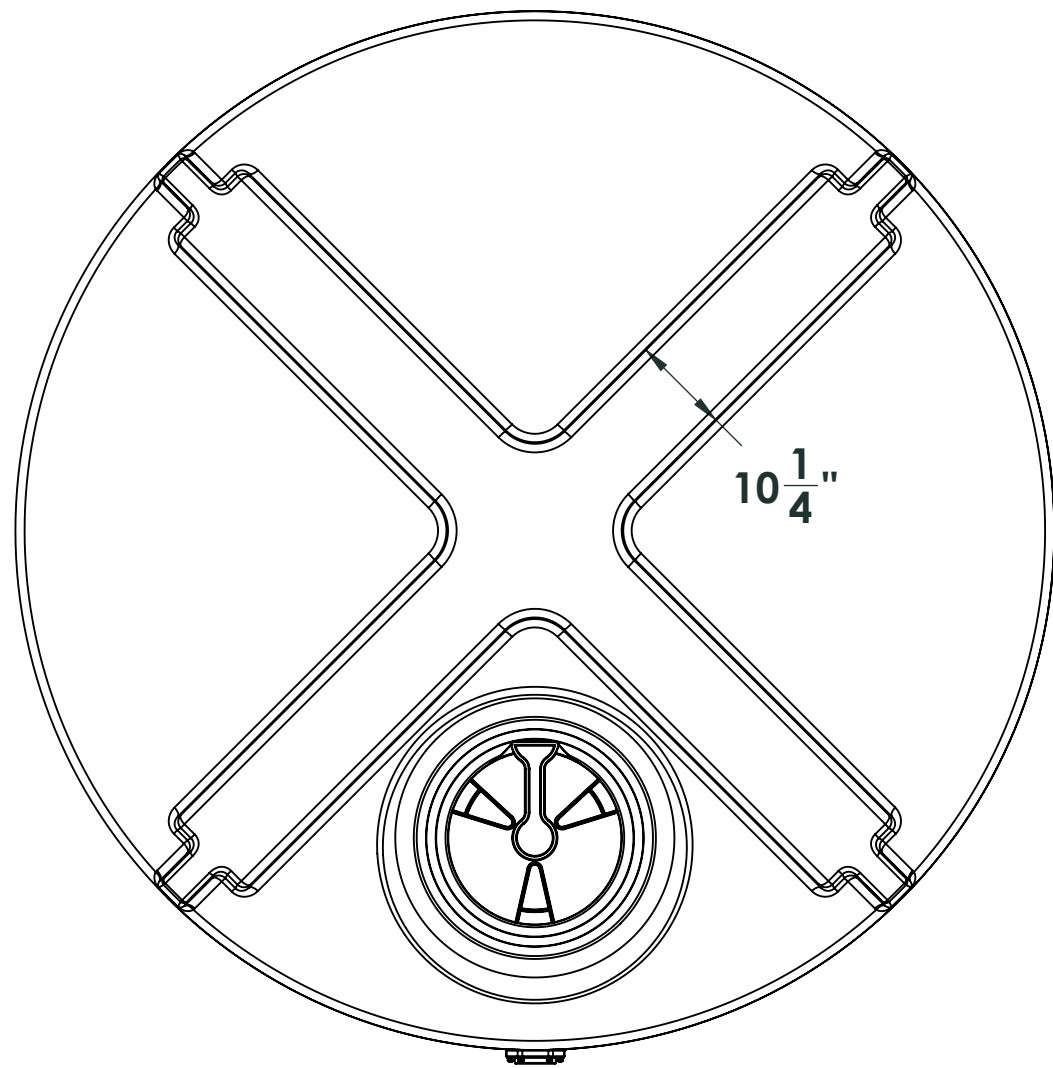

16 inch lid

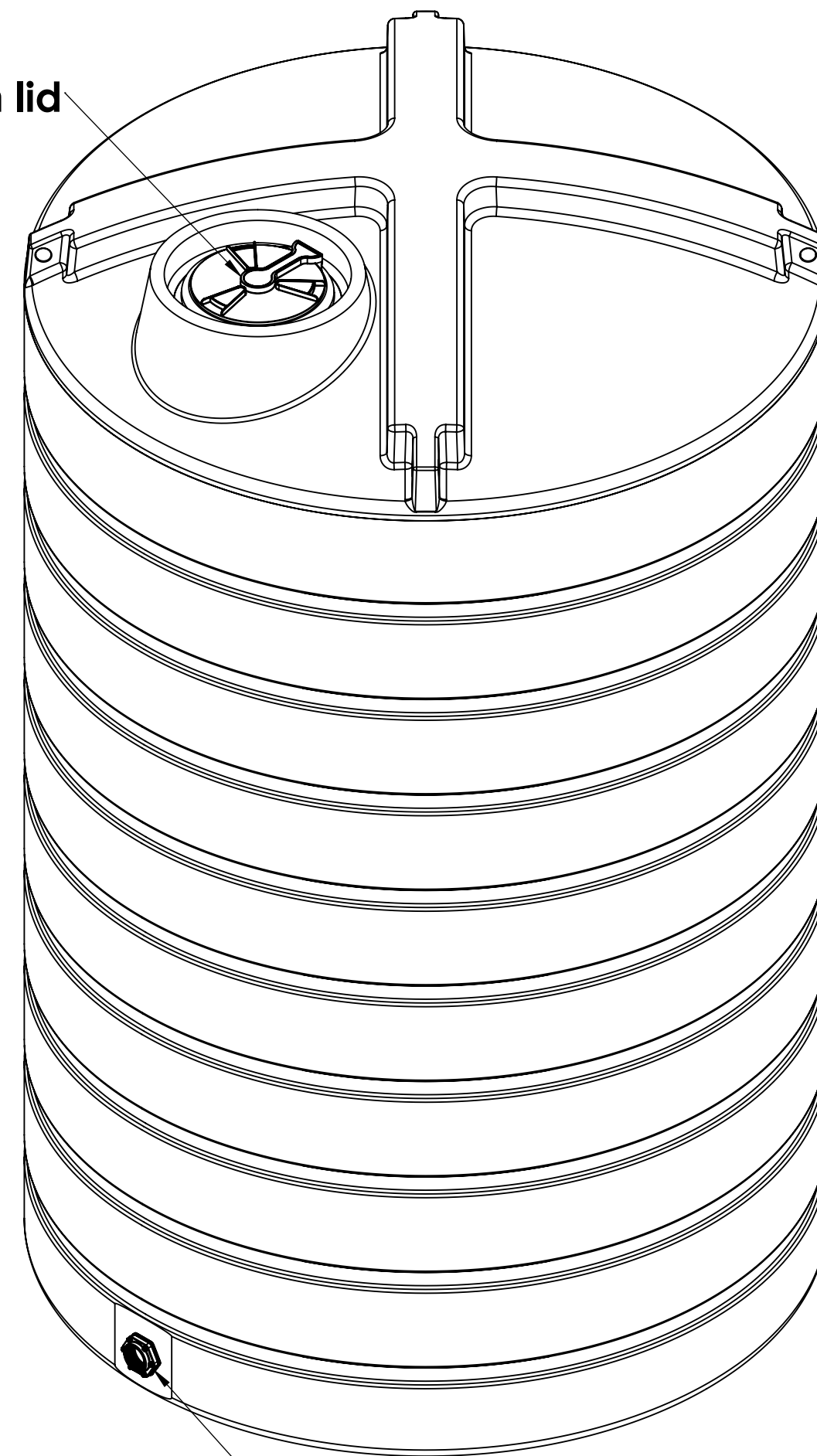

3 inch bolted fitting

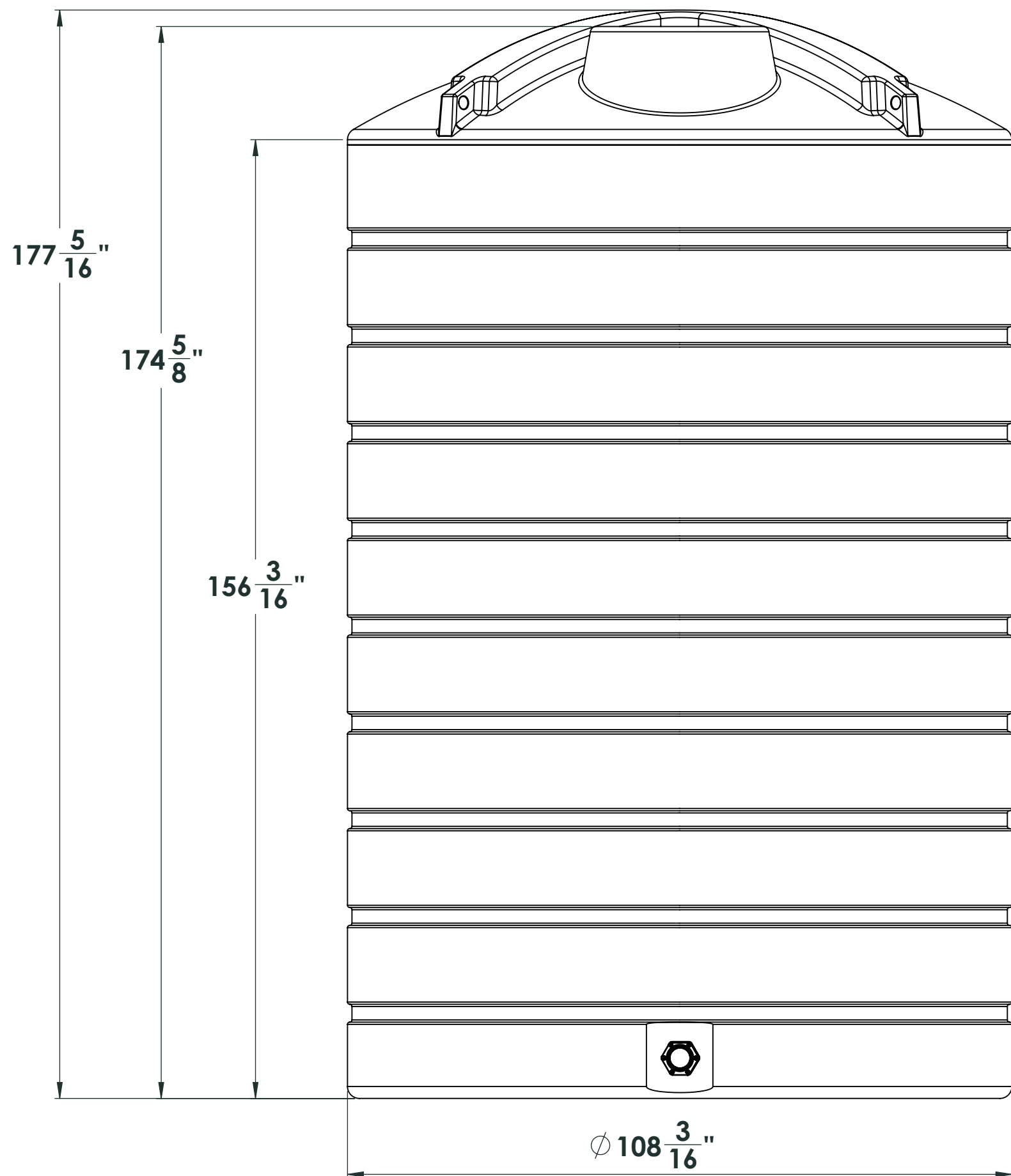

NOTE: Allow +/- 1.5% Shrinkage

PROPRIETARY AND CONFIDENTIAL
 THE INFORMATION CONTAINED IN THIS DRAWING IS THE SOLE PROPERTY OF ENDURAPLAS LLC. ANY REPRODUCTION IN PART OR AS A WHOLE WITHOUT THE WRITTEN PERMISSION OF ENDURAPLAS LLC IS PROHIBITED.

UNLESS OTHERWISE SPECIFIED:		NAME	DATE	ENDURAPLAS LLC	
DIMENSIONS ARE IN INCHES		DRAWN	DNS	11/1/16	TITLE:
TOLERANCES:		CHECKED			THV06000
FRACTIONAL ±		ENG APPR.			SIZE DWG. NO.
ANGULAR: MACH ± BEND ±		MFG APPR.			REV
TWO PLACE DECIMAL ±		Q.A.			1
THREE PLACE DECIMAL ±		COMMENTS:			SCALE: 1:50 WEIGHT: SHEET 1 OF 1
INTERPRET GEOMETRIC TOLERANCING PER:	MATERIAL	FINISH	DO NOT SCALE DRAWING		
NEXT ASSY	USED ON				
APPLICATION					